

$$S = 258,45 \text{ m}^2$$

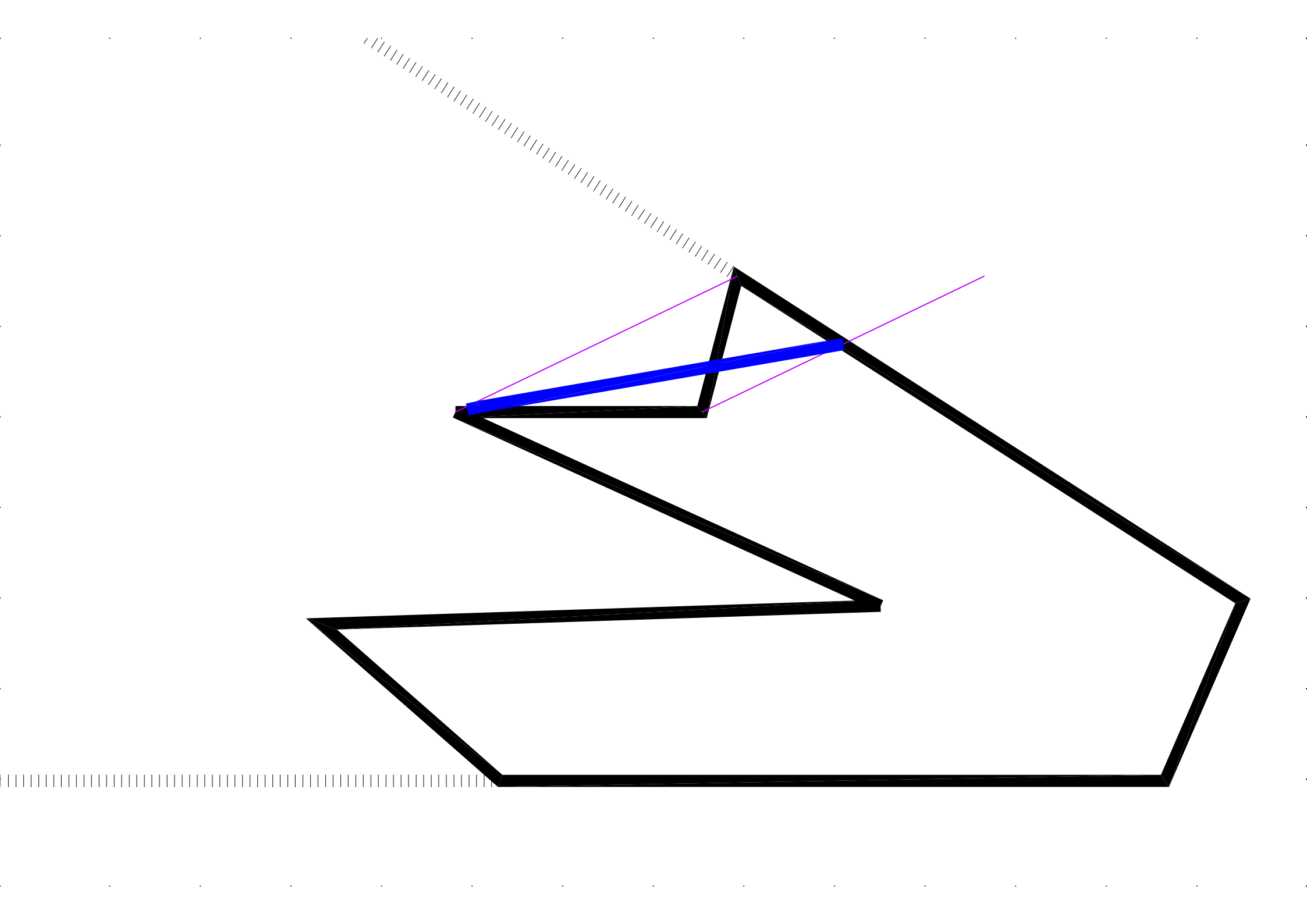

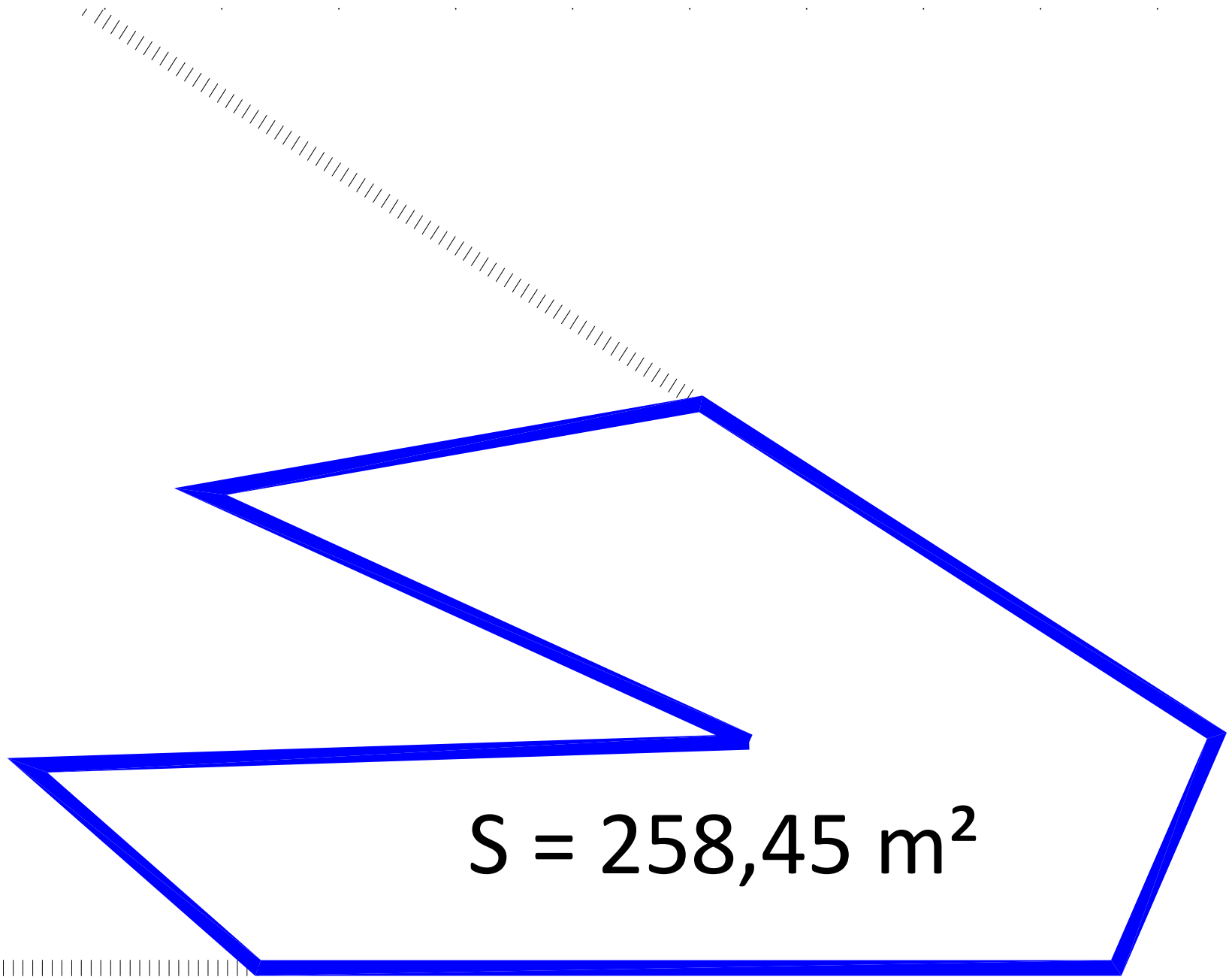

$$S = 258,45 \text{ m}^2$$

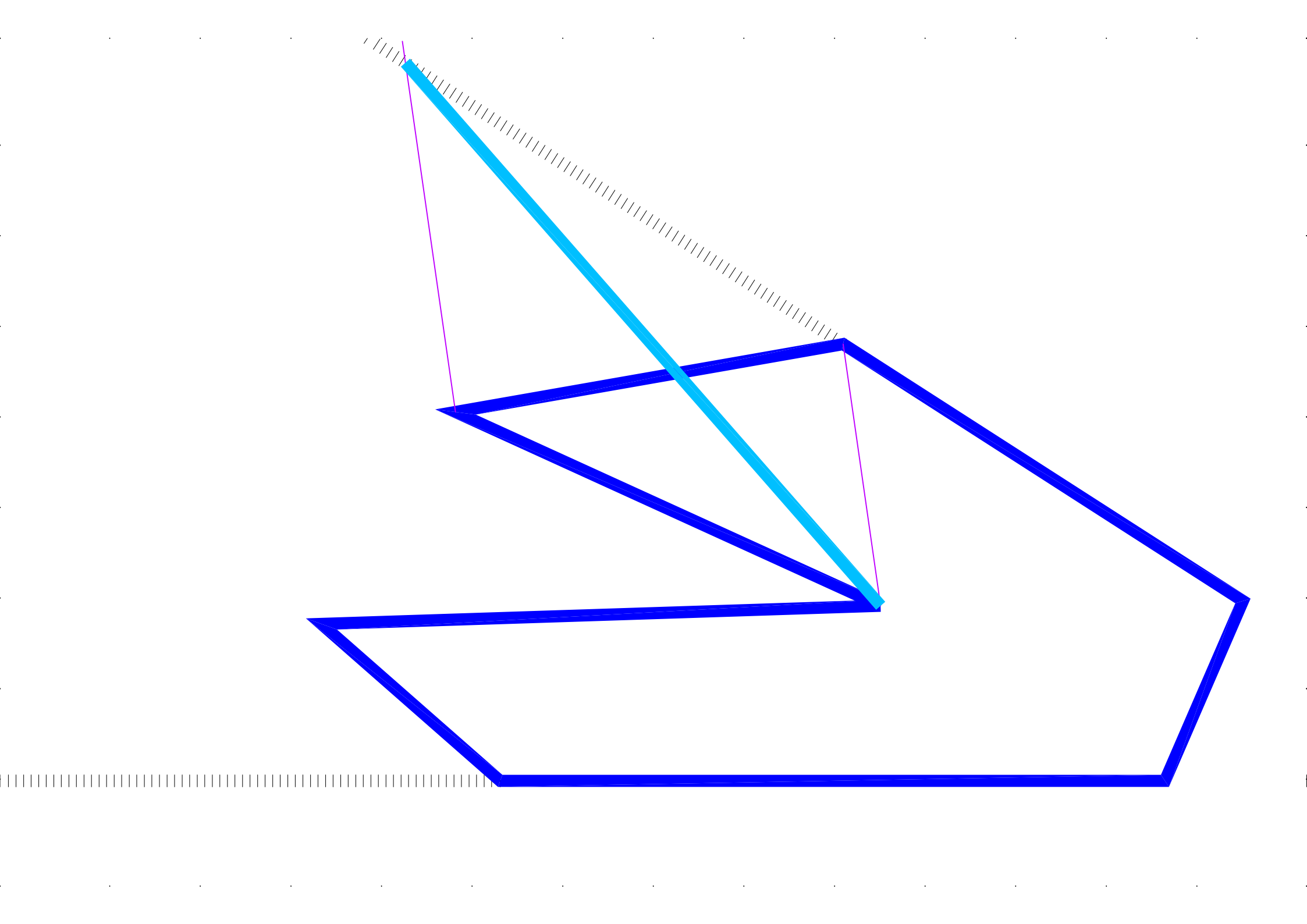

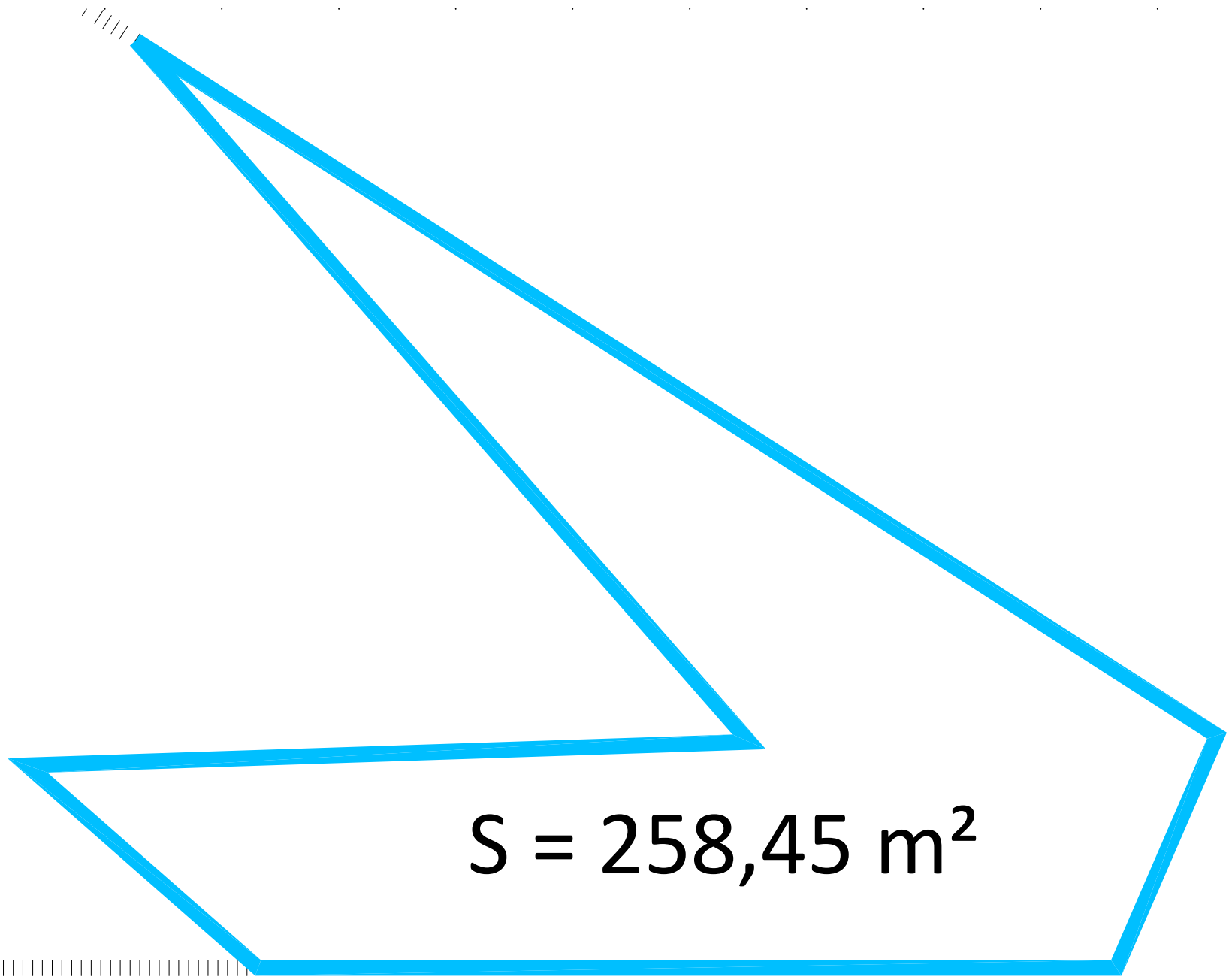

$$S = 258,45 \text{ m}^2$$

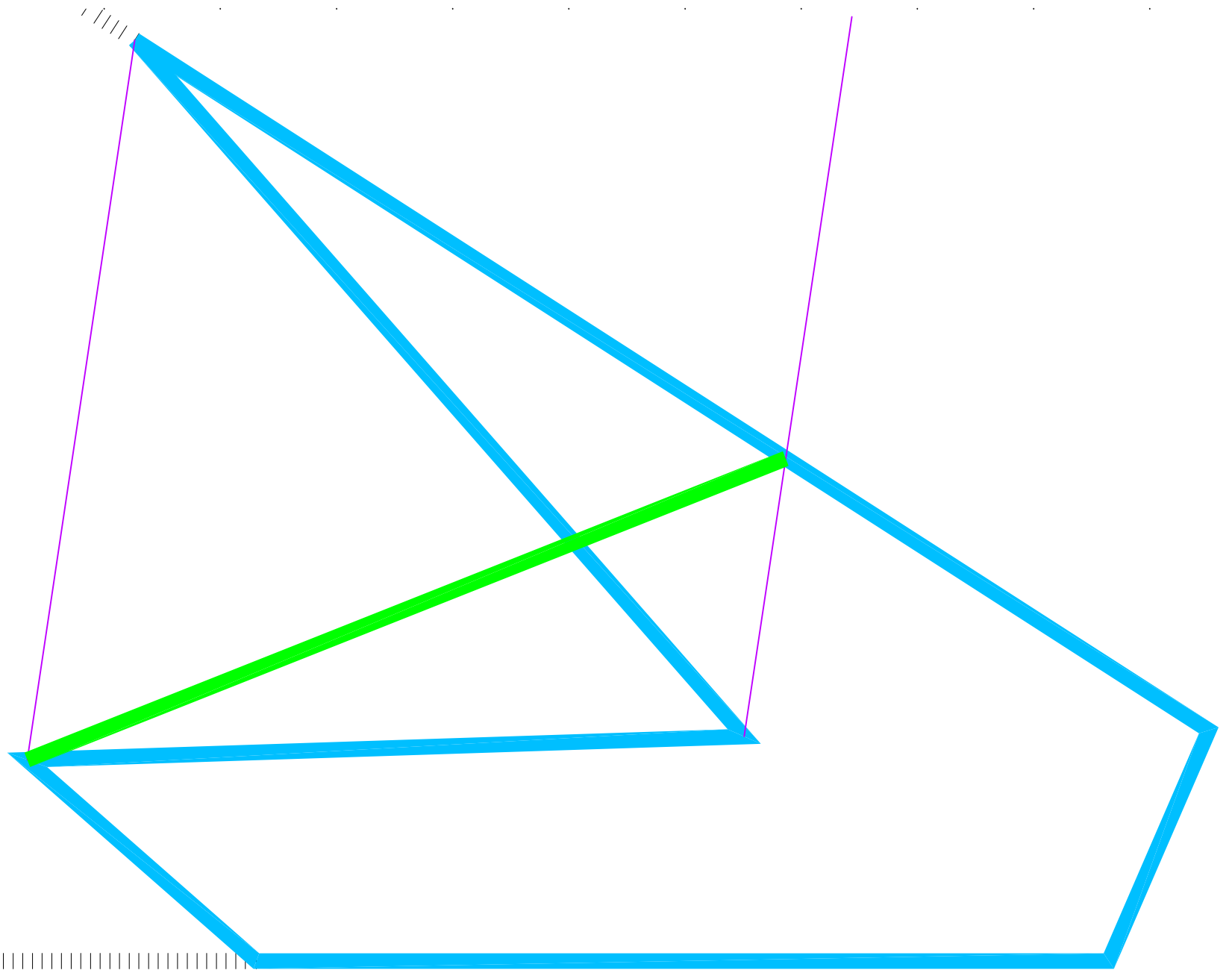

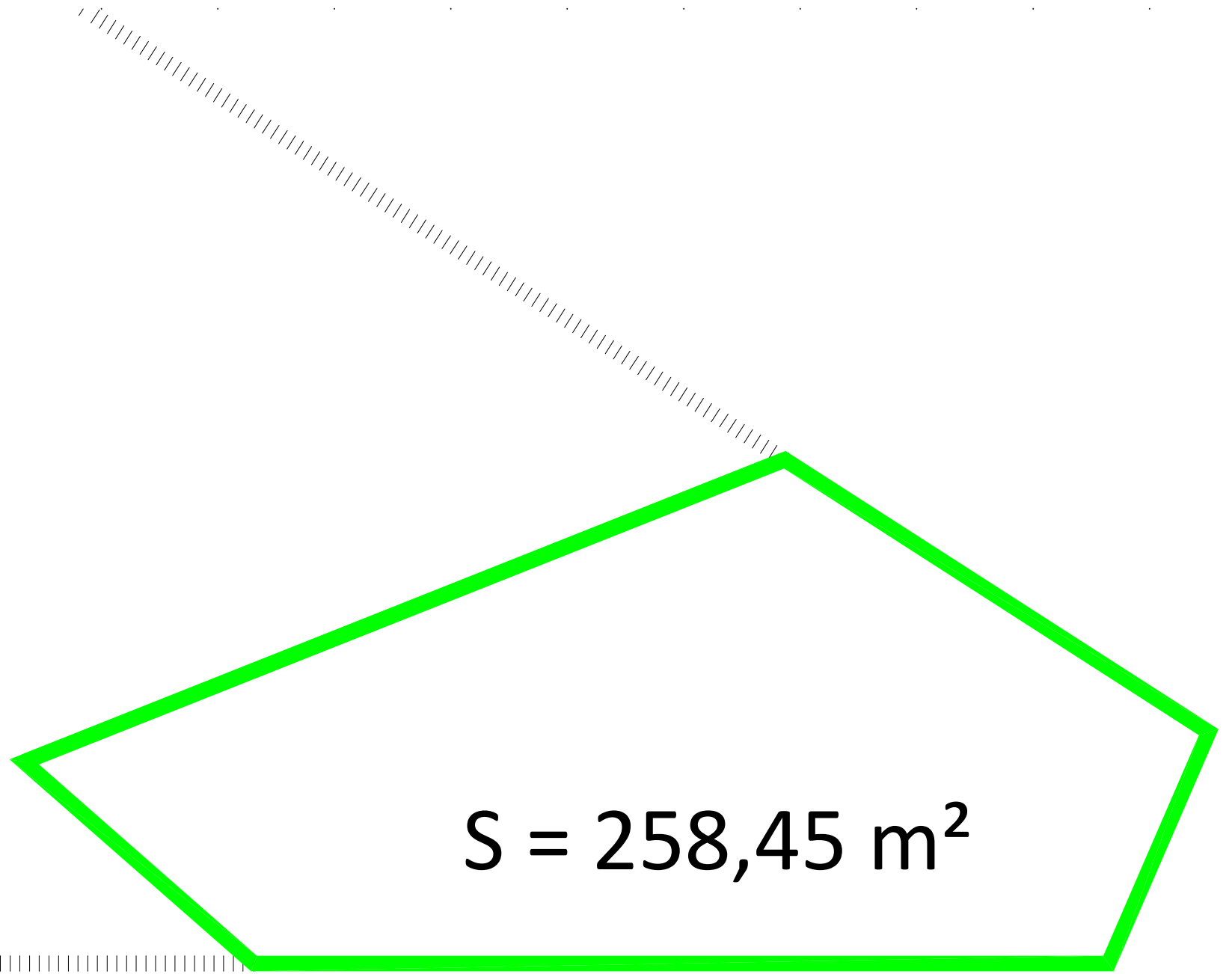

$$S = 258,45 \text{ m}^2$$

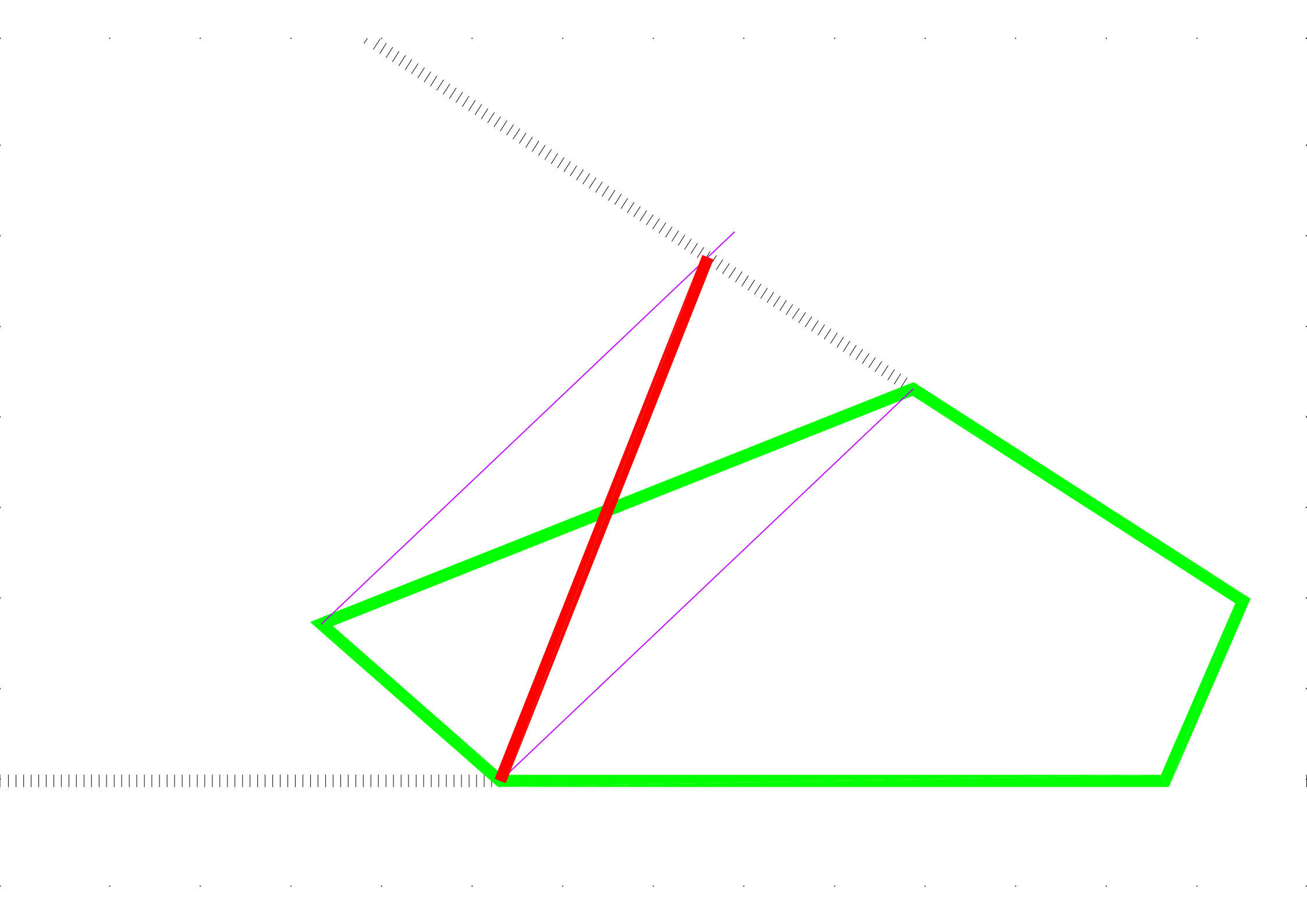



$S = 258,45 \text{ m}^2$